

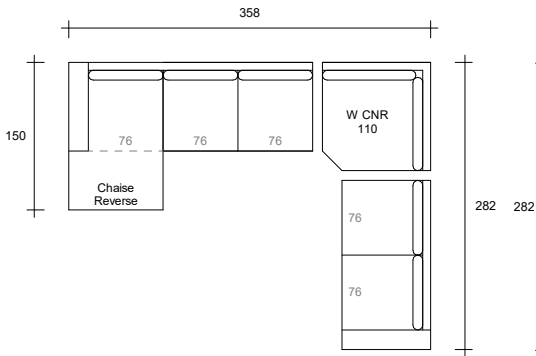

Option A
4s Trio W/CHS + CNR W + 2.5s

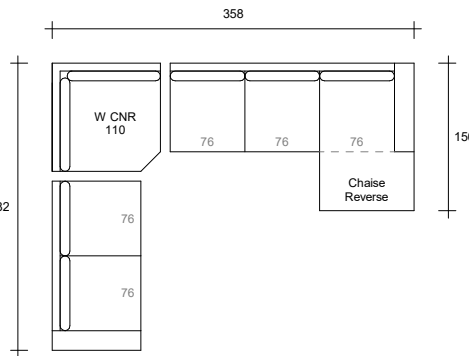

Option B
2.5s + CNR W + 4s Trio W/CHS



Option C
4s Trio W/CRN + 4s Trio W/CHS

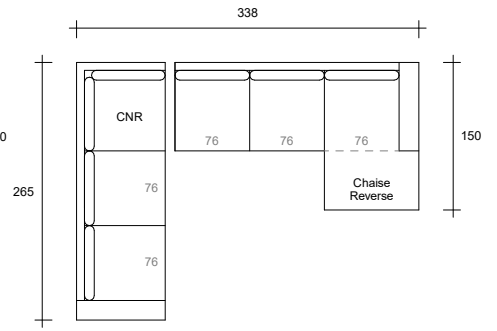

Option D
4s Trio W/CHS + 4s Trio W/CNR

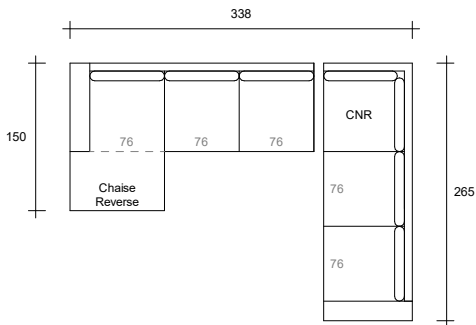

Option E
2.5s + CNR W + 2.5s

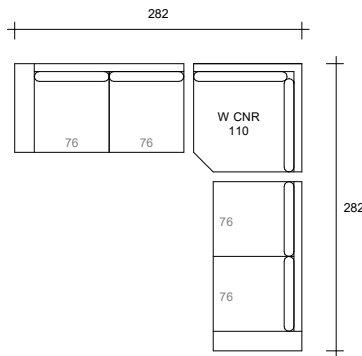

Option F
4s Trio W/CNR + 2.5s

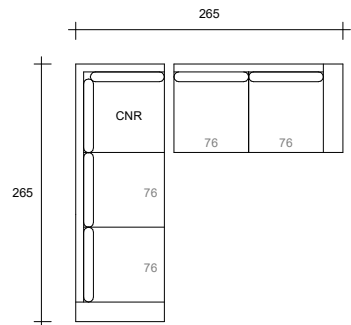

Option G
2.5s + CNR CHS RHF

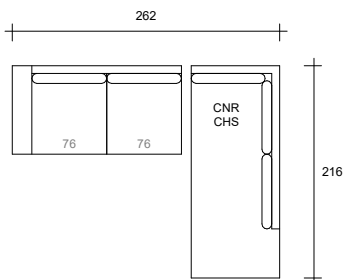

Option H
2.5s + CNR CHS LHF

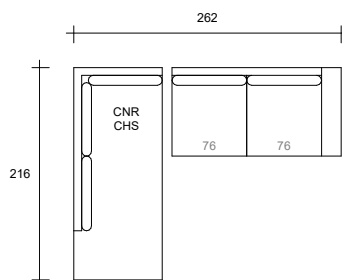

Option I
4s Trio W/CHS + 2.5s

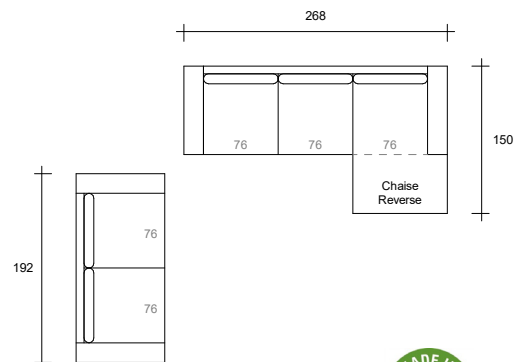

Option J
4s Trio W/CHS

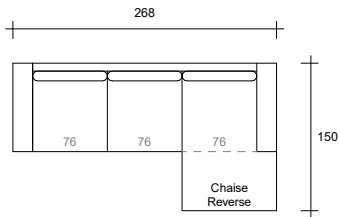

Option K
2.5s + 2.5s W/CHS

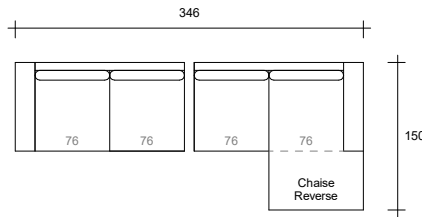

Option L
2.5s W/CHS + 2.5s W/CHS

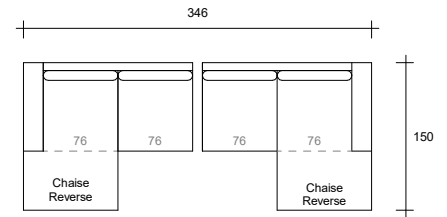

Option M
2.5s + CHS RHF

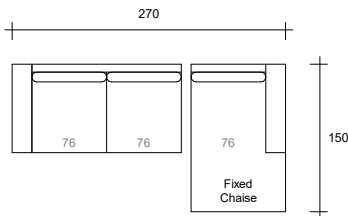

Option N
2.5s + CHS LHF

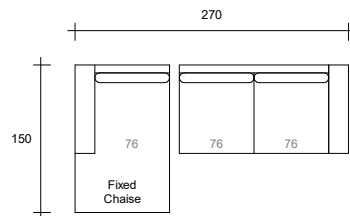

Option O
4s Trio + 2.5s

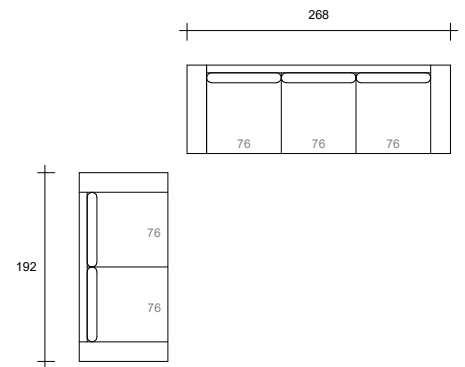

Option P
2.5s + 2.5s

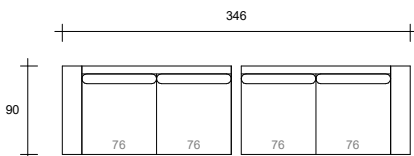

Option Q
4s Trio

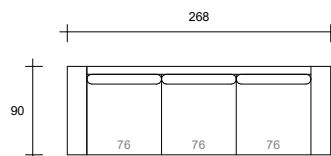

Option R
2.5s

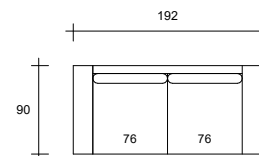

Option S
1.5s

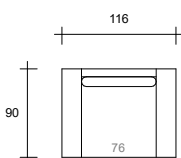

Option T
3s Queen Inn SB

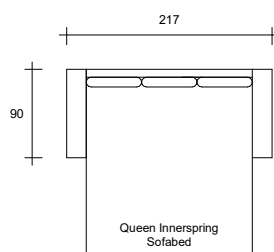

Option U
2.5s Double Inn SB

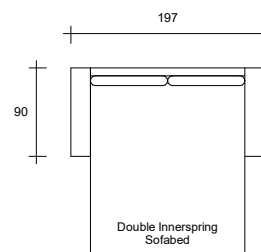

Option V
Console

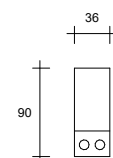

Ballina



Option A
4s Trio W/CHS + CNR W + 2.5s

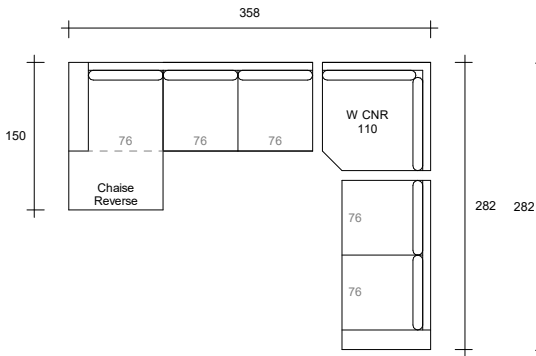

Option B
2.5s + CNR W + 4s Trio W/CHS

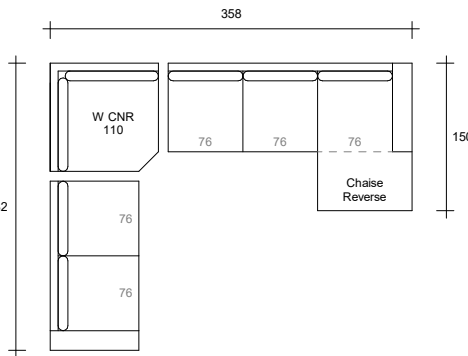

Option C
4s Trio W/CRN + 4s Trio W/CHS

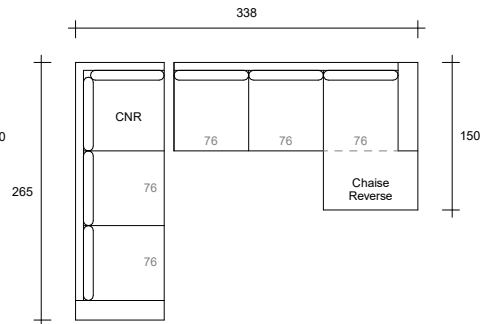

Option D
4s Trio W/CHS + 4s Trio W/CNR

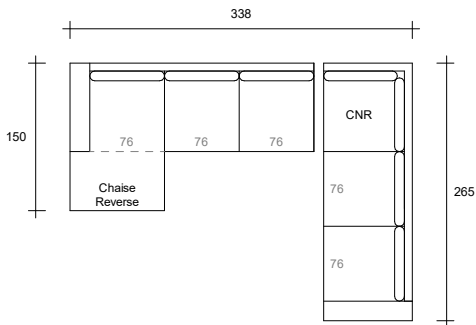

Option E
2.5s + CNR W + 2.5s

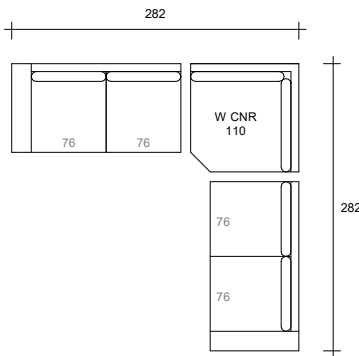

Option F
4s Trio W/CNR + 2.5s

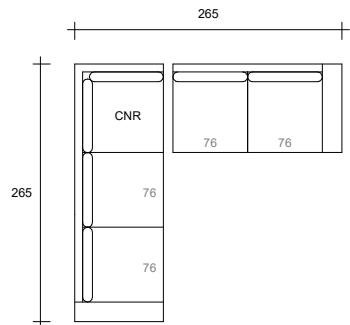

Option G
2.5s + CNR CHS RHF

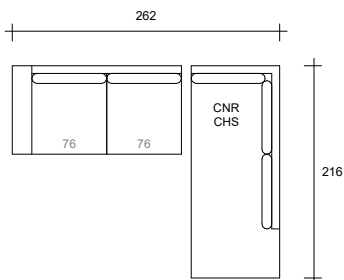

Option H
2.5s + CNR CHS LHF

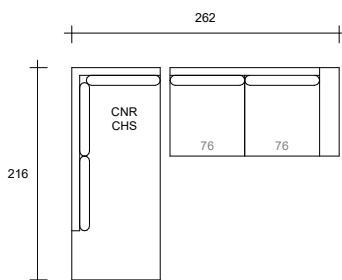

Option I
4s Trio W/CHS + 2.5s

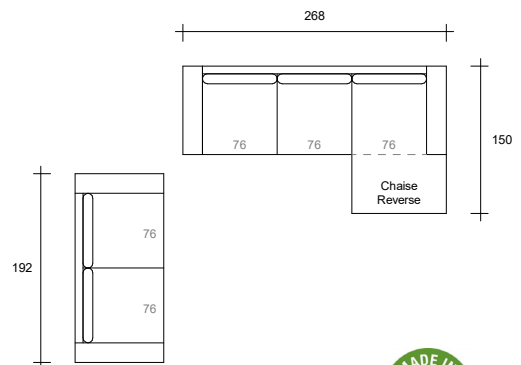

Ballina

Option J
4s Trio W/CHS

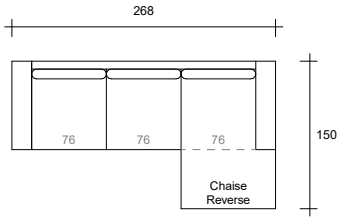

Option K
2.5s + 2.5s W/CHS

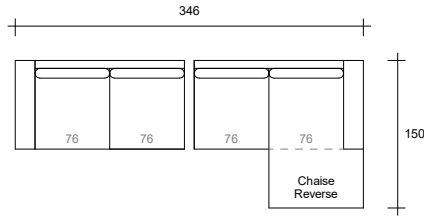

Option L
2.5s W/CHS + 2.5s W/CHS

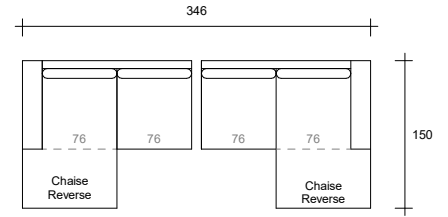

Option M
2.5s + CHS RHF

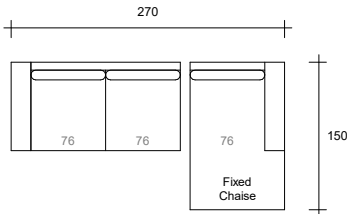

Option N
2.5s + CHS LHF

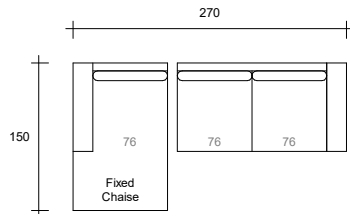

Option O
4s Trio + 2.5s

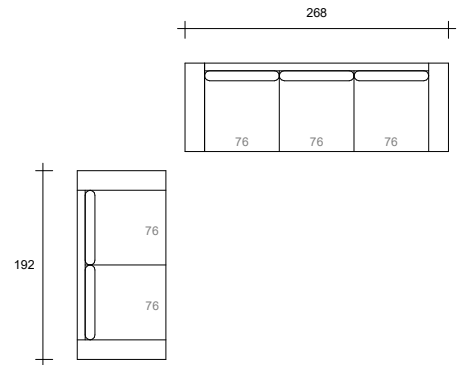

Option P
2.5s + 2.5s

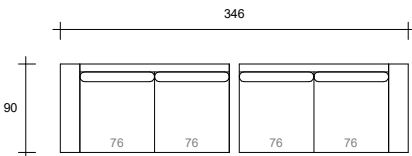

Option Q
4s Trio

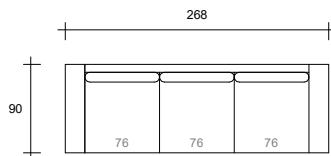

Option R
2.5s

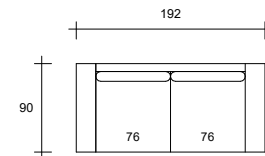

Option S
1.5s

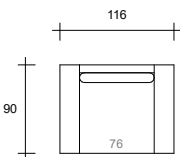

Option T
3s Queen Inn SB

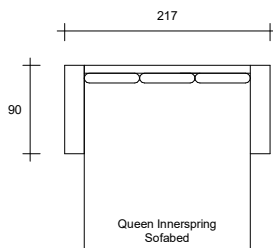

Option U
2.5s Double Inn SB

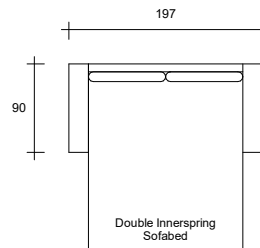

Option V
Console

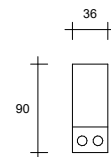

Ballina



Option A
4s Trio W/CHS + CNR W + 2.5s

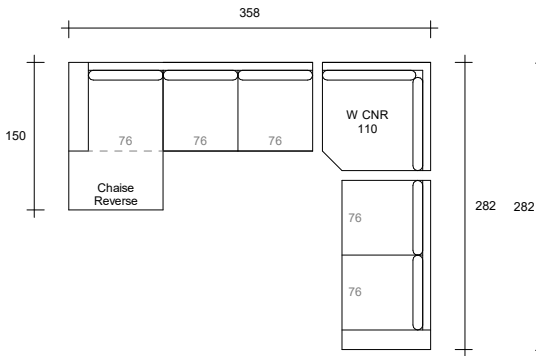

Option B
2.5s + CNR W + 4s Trio W/CHS

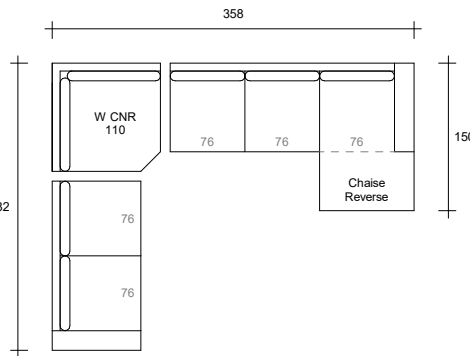

Option C
4s Trio W/CRN + 4s Trio W/CHS

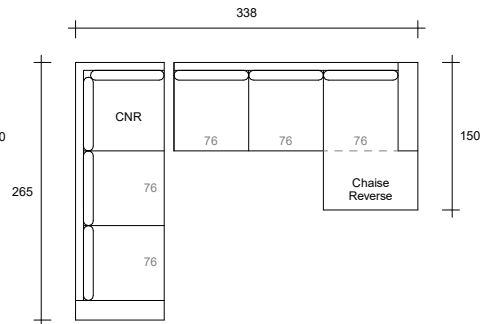

Option D
4s Trio W/CHS + 4s Trio W/CNR

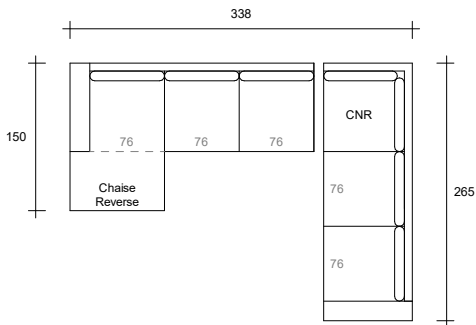

Option E
2.5s + CNR W + 2.5s

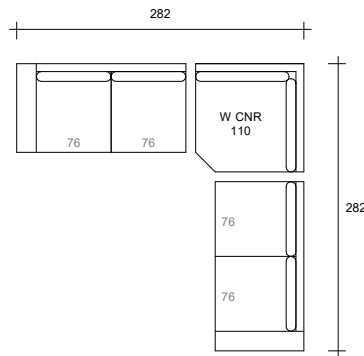

Option F
4s Trio W/CNR + 2.5s

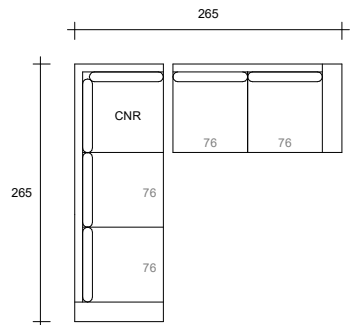

Option G
2.5s + CNR CHS RHF

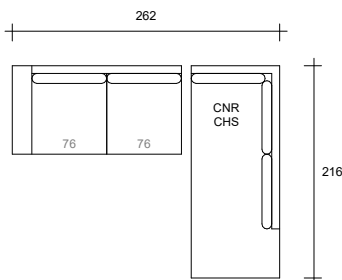

Option H
2.5s + CNR CHS LHF

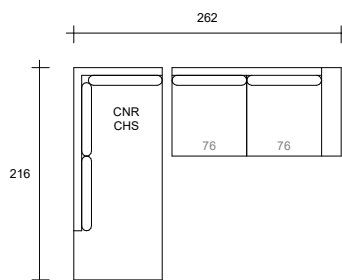

Option I
4s Trio W/CHS + 2.5s

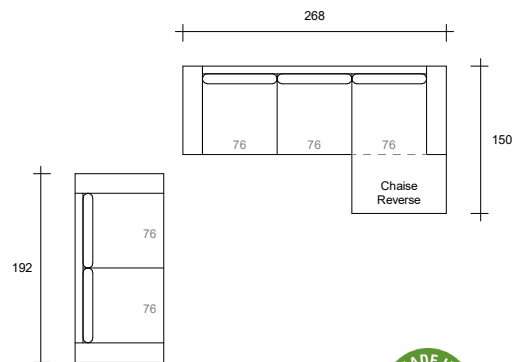

Product Disclaimer: All our furniture pieces are handcrafted in our Sydney workshop. Whilst every effort is taken to produce each item to the sample sizes as shown, slight variations may occur.



Ballina

Option J
4s Trio W/CHS

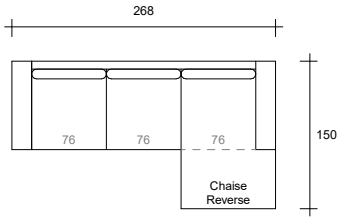

Option K
2.5s + 2.5s W/CHS

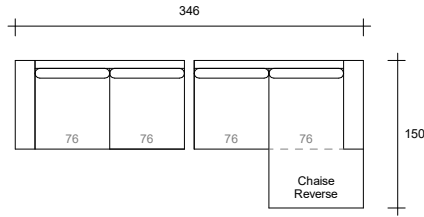

Option L
2.5s W/CHS + 2.5s W/CHS

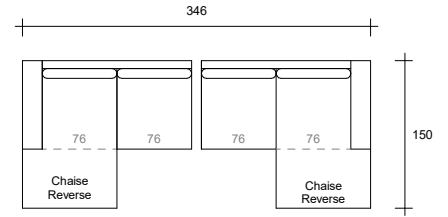

Option M
2.5s + CHS RHF

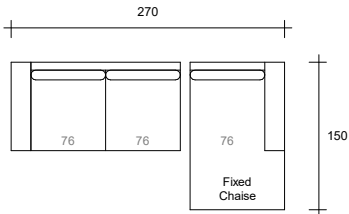

Option N
2.5s + CHS LHF

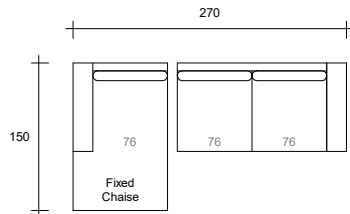

Option O
4s Trio + 2.5s

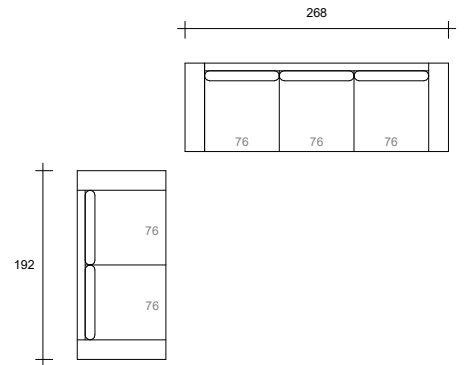

Option P
2.5s + 2.5s

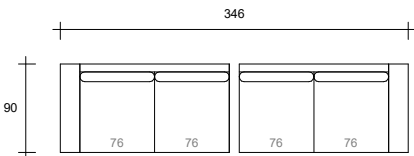

Option Q
4s Trio

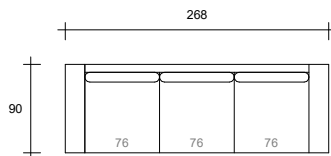

Option R
2.5s

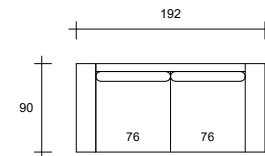

Option S
1.5s

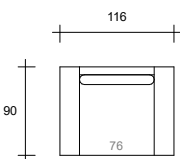

Option T
3s Queen Inn SB

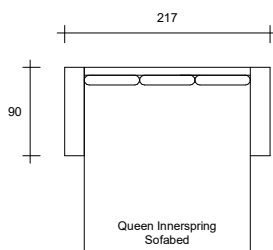

Option U
2.5s Double Inn SB

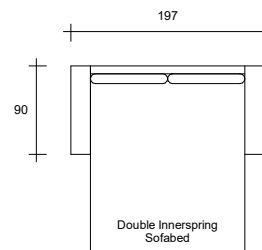

Option V
Console

