

FRAME

- Kiln dried solid plantation wood and structural composites are glued, screwed and corner blocked.

SUSPENSION

- The seat platform features No-Sag Memory Springs for superior performance, comfort and support.

SEAT CUSHIONS

- High Resilience foam is wrapped in a luxurious fiber. Foam core density is 60 kg/m³.

BACK CUSHIONS

- Siliconized fiber is contained by individually sewn channels which ensure even distribution and minimize the need for maintenance.



1.5 SEAT



SIDE VIEW



2.5 SEAT



2 SEAT



2.5 SEAT HB



3 SEAT



3 SEAT DUO



3 SEAT DUO HB



3.5 SEAT

Construction Features

- Frames are made from solid wood and laminated structural composites
- All corners are reinforced with corner blocks
- No-Sag Memory Sprung Seat
- Foam core density in seat foam is 60 kg/m³
- Channelled Siliconized Fiber back cushion
- Wood legs
- 2 seat cushions on 3 seater

Options

- All IMG leathers, fabrics and wood colors can be selected
- 3 seat cushions on 3 seater
- 2.5 seater and 3.0 Duo with choice of high back.

Exclusive Warranty



10 years on molded foam cushions and steel frames
 5 years on mechanisms
 2 years on motor and battery-parts
 2 years on leather and fabric covers

10 YEAR WARRANTY DESIGNED IN NORWAY

See warranty policy for more details.

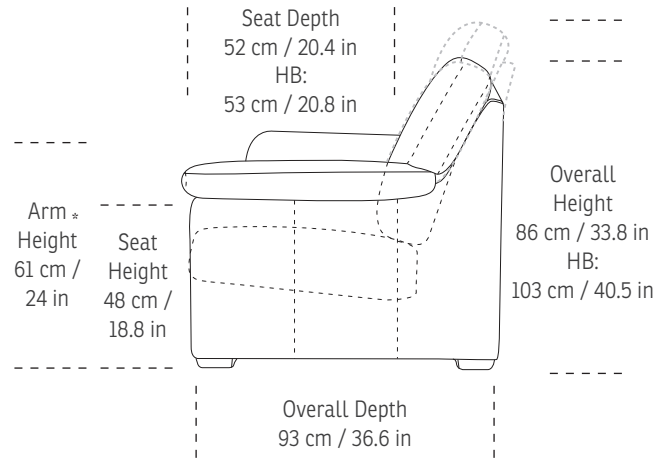

*Note: Arm height for this frame is measured at the highest point of the arm.
 *The dimensions are approximate and may vary with +/- 2cm.

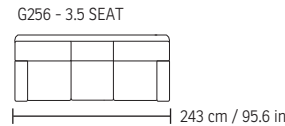
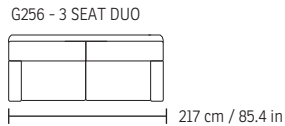
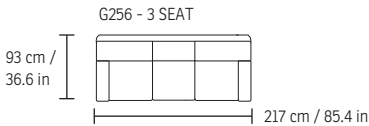
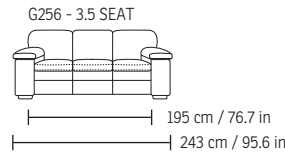
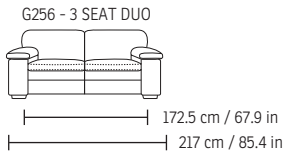
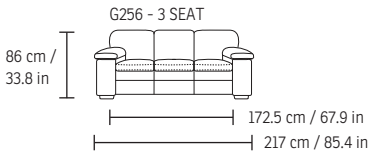
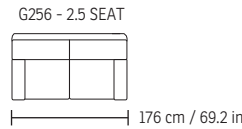
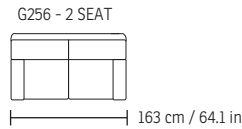
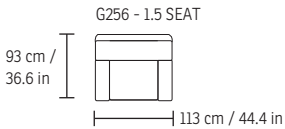
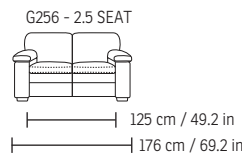
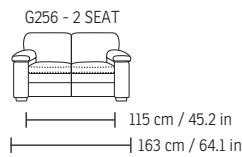
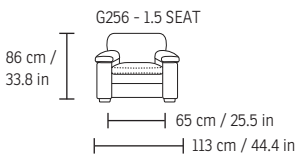

HIGH BACK

